

SKYPAD

User Manual

Version 1.0.3

March 2007

Revision History

Version	Date	Author	Comments
1.0	May 2005	Troy Sun	First release
1.0.1	May 2005	Troy Sun	Some keyword replace.
1.0.2	June 2005	Troy Sun	Revise for the AP v1.0.4. The Mail Synchronization adds the function for data update in the specific period.
1.0.3	March 2007	Vincent Lin	Add Disk Partition.

Table Of Contents

1. INTRODUCTION	6
1.1 FUNCTIONS FEATURES	6
1.2 FUNCTION ARCHITECTURE	7
1.3 SUPPORTED PLATFORM	7
1.4 RUN THE PROGRAM	8
2. FUNCTIONS OPERATION	9
2.1 CONTROL PANEL	9
2.2 ABOUT	10
2.3 OPTION	11
2.3.1 <i>Plug-in Prompt Enable</i>	11
2.3.2 <i>Autorun Enable</i>	11
2.3.3 <i>PC Lock Enable</i>	11
2.3.4 <i>Panel Enable</i>	11
2.3.5 <i>Panel on the Top</i>	11
2.3.6 <i>Start-up by System</i>	12
2.4 PRIVATE ZONE LOGIN	13
2.4.1 <i>Change the Password and Hint</i>	14
2.4.1.1 <i>Force to Change the Password and Hint</i>	11
2.4.2 <i>Change the Space of the Private Zone</i>	15
2.4.3 <i>Trouble Shooting</i>	
2.5 PC LOCK	16
2.6 FILE ENCRYPTION	17
2.7 AUTORUN	18
2.8 DOS BOOT	20
2.9 FILE SYNCHRONIZE	21
2.9.1 <i>Synchronize File List</i>	22
2.9.2 <i>Trouble shooting</i>	
2.10 MAIL SYNCHRONIZE	23
2.10.1 <i>Synchronize Mail from PC to USB Flash Drive</i>	24
2.10.2 <i>Synchronize Mail from USB Flash Drive to PC</i>	25

2.10.3 Trouble Shooting

Introduction

1.1 Functions Features

This application is the utility for **SKYMEDI** USB flash controller. There are many features for users' utilization and help them to keep their data safety. The AP has a small control panel to handle all of the functions and monitor with the USB flash drive by a watchdog.

Here is a brief introduction for the feature of the application.

- **Head-up control panel**
A head-up control panel guides users to utilize all of the functions.
 - **The resident watchdog**
It helps the control panel to monitors the USB flash drive status.
 - **Plugin/Remove device prompt**
Configurable pop-up prompt can notify users when the device adding or removing.
 - **Private Zone**
A hidden partition keeps the user's confidential data.
 - **Disk Partition(Optional)**
The USB flash drive can be partitioned into two logical disks (volumes).
 - **PC Lock**
A screen protector avoids the strangers glance the screen while the users go away from their computer.
 - **File Encryption**
Encrypt/Decrypt the specific files.
 - **Autorun**
Automatically runs the specific programs/files while the USB flash drive plugging in.
 - **DOS Boot**
Let the system boot to the DOS mode from the USB flash drive.
 - **File Synchronization**
Synchronize the specific folders according to the last modification time.
 - **Mail Synchronization**
Synchronize the **Outlook**[®] data that include mail inbox, mail outbox, Journal, drafts, notes and address book.
-
-

1.2 Function Architecture

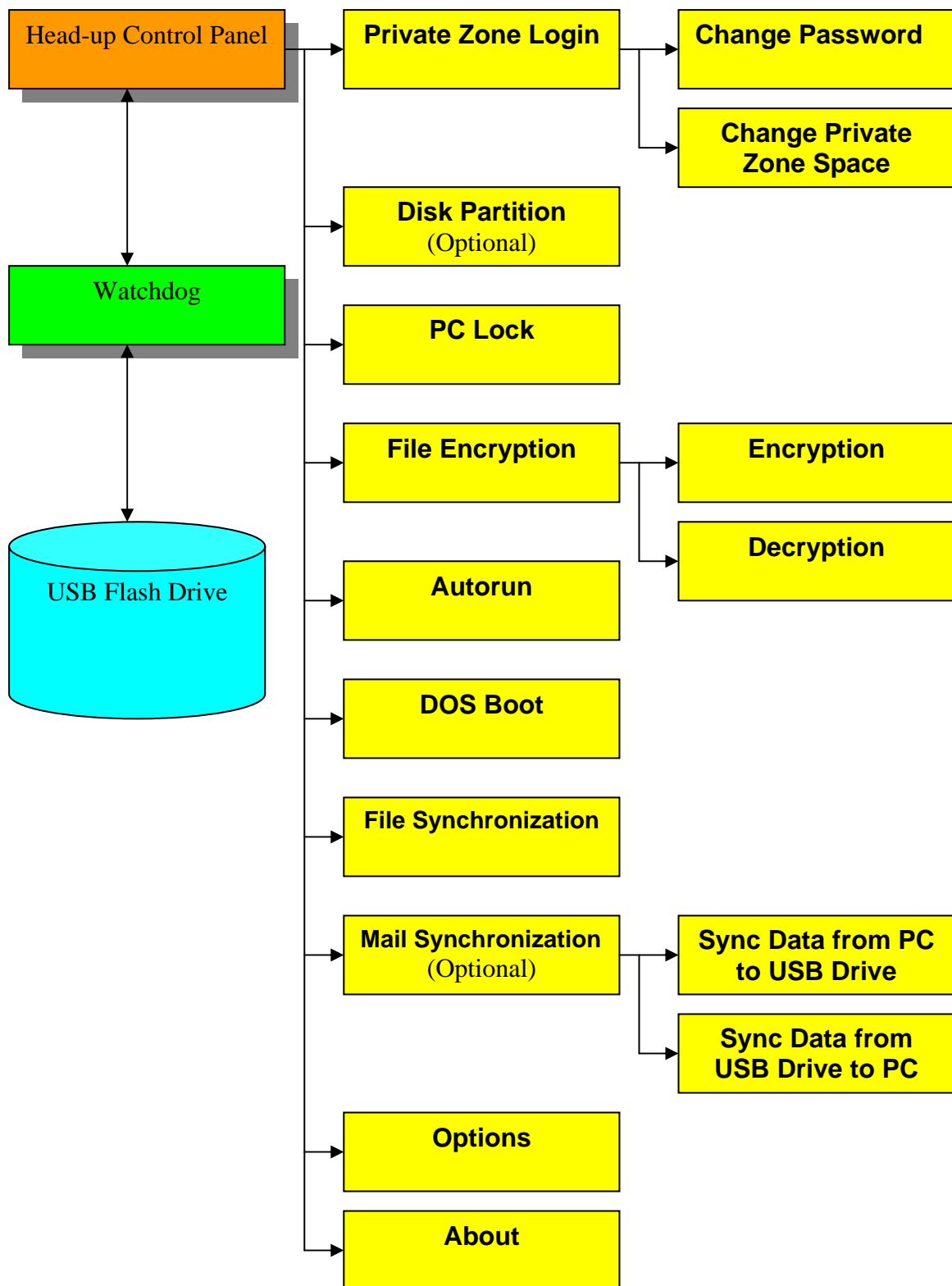

1.3 Supported Platform

Windows® Vista/XP/2000/ME/98 only. A privileged user is needed for running the program in Window[®] XP/2000.

Language Support: Total 11 languages support and detect automatically. Traditional Chinese, Simple Chinese, English, Japanese, Korea, German, French, Italian, Russian, Spanish and Portuguese.

1.4 Run the Program

1. Make sure the program **Skypad.exe**, **IMailDll.dll**, **TaskKeyHook.dll**, and **XceedZip.dll** at the same path.
2. Run the execution file **Skypad.exe** by double click.
3. If the USB flash drive has not plugged in, only the watchdog icon at the tray of the right-bottom screen. 
4. If the USB flash drive has already plugged in, the head-up control panel will pop-up to the right-up screen.
5. If “PC LOCK” had been set and there is not any supported USB flash drive, **don't** run the program.

2. Functions Operation

2.1 Control Panel

The control panel handles all of the functions. The usable space of the USB flash drive is displayed on the top.

 The **Option** button pulls down the functions list for the users' utilization as shown as the right figure. Some of these functions, Private Zone Login, Disk Partition, and DOS Boot, are disabled, when ReadyBoost[®] is enabled.

If your USB flash drive has two logical disks (volumes), the letter of the two logical disks will be put on the top of the menu. Some functions, like Private Zone Login and DOS Boot are for individual logical disk. For example, if you would like login to the private zone of disk J, please click the menu item, J:\, and then click Private Zone Login.



 The **Hidden** button iconizes the control panel to the right-bottom. To show the control panel again, click watchdog icon by right mouse key and choose the item, Utility.

 The **Eject** button safely removes the USB flash drive. If another application has an open connection to your USB flash drive, please close all applications and documents open on the USB flash drive and try again.

2.2 Watch Dog

The watchdog helps guides users to control

2.3 About

Click the **About** item at the pull-down manual will pop-up the manufacture logo and some information.



2.3 Option

Click the **Option** item at the pull-down manual will pop-up the **Option** dialog. It can turn on/off the specific settings to customize the application.



Save the setting and close the dialog.



Abort the setting and close the dialog.



2.3.1 Plug-in Prompt Enable

Check the item to pop-up the plug-in dialog as the device plugin/removing.

2.3.2 Autorun Enable

Check the item to enable the **Autorun** function and the item will appear on the pull-down manual.

2.3.3 PC Lock Enable

Check the item to enable the **PC Lock** function and the item will appear on the pull-down manual.

2.3.4 Panel Enable

Check the item to show the control panel on the screen.

2.3.5 Panel on the Top

Check the item to let the control panel always on the top window.

2.3.6 Start-up by System

Check the item to let the system execute the application while the system boot up.

2.4 Private Zone login

This function will login to the private zone. This zone is hidden while the USB flash drive plug-in. The users must input the correct password to get the private zone.



This button let the users to change the **Password** and **Hint**. Users must key in correct password then click the button to change password. See **2.4.1 Change the Password and Hint**.

If forgetting the password, users can force to change the password. But all of the data in the Privacy Zone will be erased. See **2.4.1 Force to Change the Password and Hint**.



This button let the users to change the space of the private zone. Users must key in correct password then click the button to change the space of the private zone. See **2.4.2 Change the Space of the Private Zone**.



Confirm the password and try to login to the private zone. If Private Zone does not exist, this button will be hidden.



Cancel the login and close the dialog.

2.4.1 Change the Password and Hint

Input the new password and hint to save to the USB flash drive.

The length of **Password** and **Hint** is depended on the kind of USB flash drive. Skypad will detect automatically the kind of USB flash drive and limits the max length you can key in.





Confirm the new password and save to the USB flash drive. If the two passwords which you key in are not identical, the error message will appear.



Cancel the setting and close the dialog.

2.4.1.1 Force to Change the Password and Hint

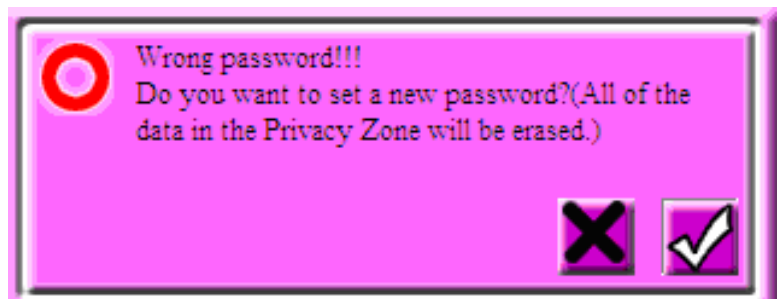
Clicking New Password button with wrong password will bring the dialog in the right. If you really forgot the password, you could click OK. After all the data in private zone had been erased, you can set a new password as **2.4.1 Change the Password and Hint**.



***Warning: All of the data in the Privacy Zone will be erased.**

2.4.2 Change the Space of the Private Zone

Users can adjust the scroll bar to change the space of the private zone or key-in the security space or visible space directly to change the partition. The size of Visible Space has to be more than 10MB.

*** Warning: Change the space of the private zone will initiate format operation to the USB flash drive and all of the data on the flash drive will lose. Please backup the data before running this function.**



Confirm the setting and save to the USB flash drive. Please close all applications and documents open on the USB flash drive before clicking the button, otherwise the error message will appear.



Cancel the setting and close the dialog.

2.5 PC Lock

This function let the USB flash drive become a screen protector to avoid unauthorized persons glance the screen when the users leave their computer.

The **Display Text** shows the text in the screen when the USB flash drive is removed. The **Lock Period** is the duration of the screen lock. If the users check the **Power Down and Lock** box then the system will shut down as the OK button clicking.

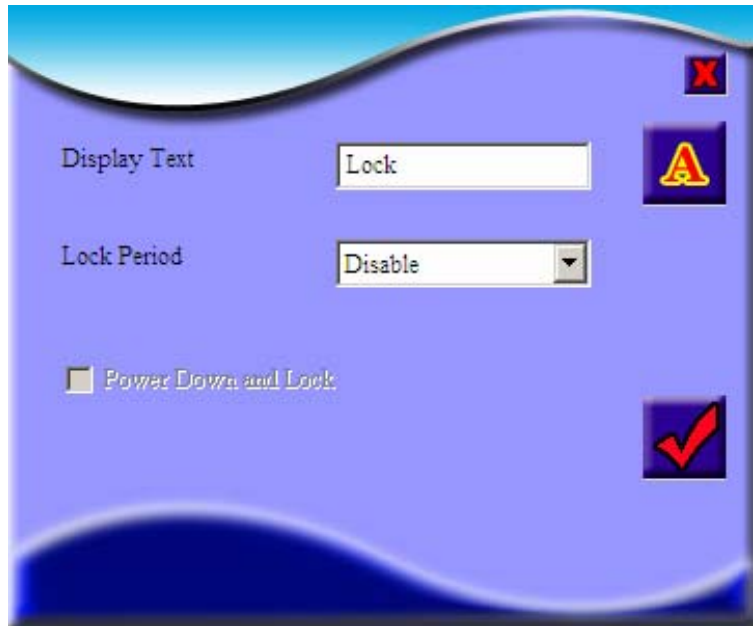

*** Warning: When you set the Lock Period and remove the USB flash drive, the PC will be protected with black screen until the USB flash drive plug-in again. Please keep the USB flash drive carefully.**



Click this button to select the font for the Display Text.



Confirm the setting and save to the USB flash drive. If the **Power Down and Lock** is checked, then the system shut down right now. And the system will execute Skypad automatically while the system boot up. Make sure your USB flash drive is available while the system boot up next time, otherwise the system will be locked.



Cancel the setting and close the dialog.

2.6 File Encryption

This function let users to encrypt or decrypt the specific files. If the **Replace the Existing Files** is checked, the encrypted or decrypted files will replace the files got the same file name. Please make sure the target file is writeable if **Replace the Existing Files** is checked.

The **Password** and **Hint** have to be less than 16 characters.

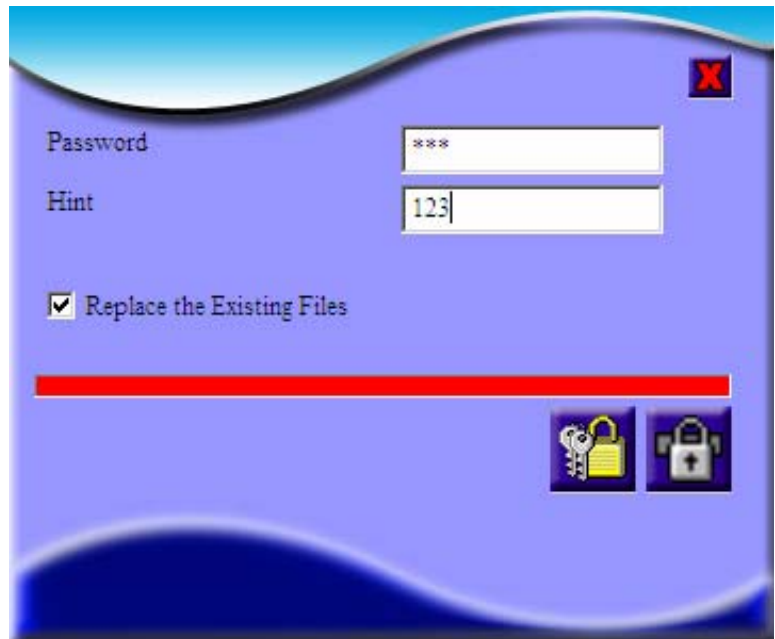

Encryption button let the users to select the specific files to encrypt. It needs to input the **Password** and **Hint** before clicking this button.



Decryption button let the users to select the files to decrypt. It allows leaving blank in the **Password** before click this button. If the **Password** dose not input, the program will prompt a dialog to guide the users to input the password. If different files have different passwords, the prompt dialog would pop-up for every file.

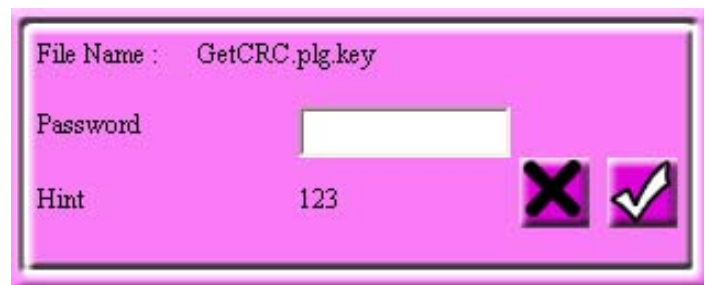

Cancel the setting and close the dialog.

2.7 Autorun

This function let the system to auto run the specific files while the USB flash drive plug-in. Before the USB flash drive plug in, **Skypad** must had run in the system in advance.

There are three auto-run modes can be selected.

Execution Autorun.inf

It is according to the **Autorun.inf** to execute the specific file. This **Autorun.inf** and executed file must exist in the root path of the USB flash drive. The Autorun.inf must contain the string, "open=Filename.exe" You can find how to write a full **Autorun.inf** from <http://support.microsoft.com/kb/818804>.

If there are two logical disks (volumes) in your flash drive, **Skypad** will search **Autorun.inf** in the first volume. If **Autorun.inf** does not exist in the first volume, **Skypad** will continue to search it in the other volume.

Execution Files

It is according to the input file name. The file can exist in any place of the system. It also supports the Microsoft Word, Excel and PowerPoint file types, but the system must install those applications in advance. You must select file through clicking the file browser button.

Execution WWW

It will run the default web site explorer with the WWW address.

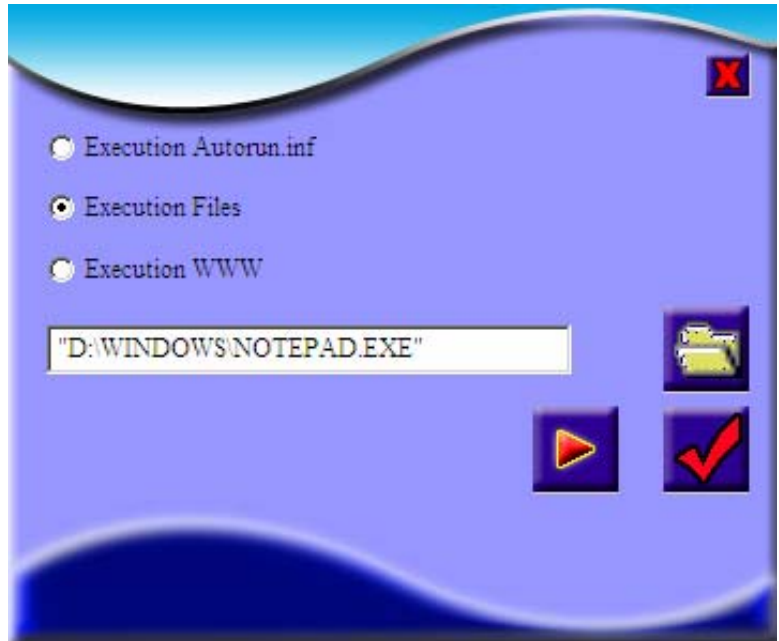

The file browse button helps the users select the auto run files. If **Execution Autorun.inf** or **Execution WWW** is checked, this button is disabled.



The test button helps the users test the auto run setting.



Confirm the setting and save to the USB flash drive.



Cancel the setting and close the dialog.

2.8 DOS Boot

Let the system boot in the DOS mode as the PC starts with the USB flash drive. It supports two file system modes FAT16 and FAT32.

The BIOS need to configure the boot sequence for USB flash drive is the first boot priority. For some systems, you could press F8 or other function key to select what device the system boot up from.

***Warning: Write the DOS boot files will format the USB flash drive and all of the data will lose. Please backup the data before running this function.**

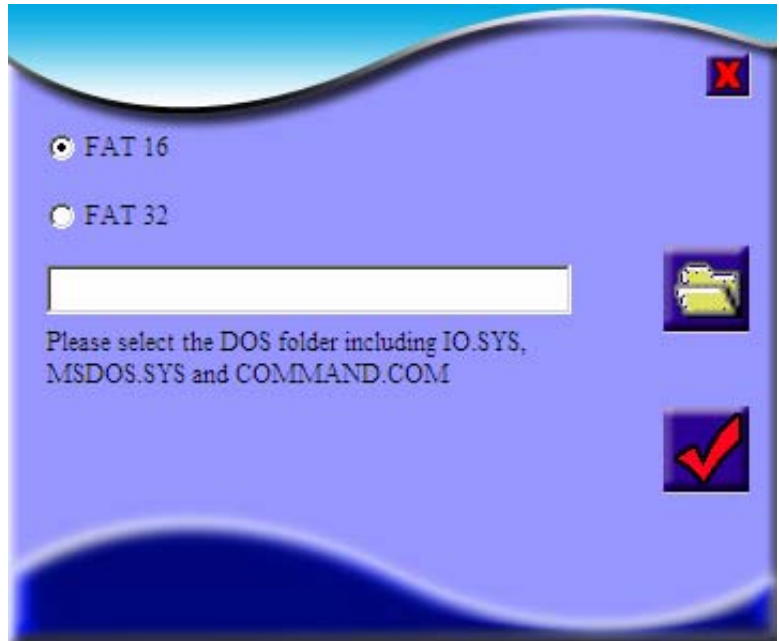

The file brows button helps the users to select the DOS boot files including IO.SYS, MSDOS.SYS and COMMAND.COM.



Confirm the setting and write the DOS boot files to the USB flash drive. Please close all applications and documents open on the USB flash drive before clicking the button, otherwise the error message will appear.



Cancel the setting and close the dialog.

2.9 File Synchronize

This function let users synchronize files for the specific folders. It is according to the last modification time of the files.

There are three synchronization modes for different file path.

Synchronize Folder

It can select any specific folder to synchronize data.

Synchronize My Favorites

It can auto setting the specific folder to My Favorites.

Synchronize My Document

It can auto set the specific folder to My Document.

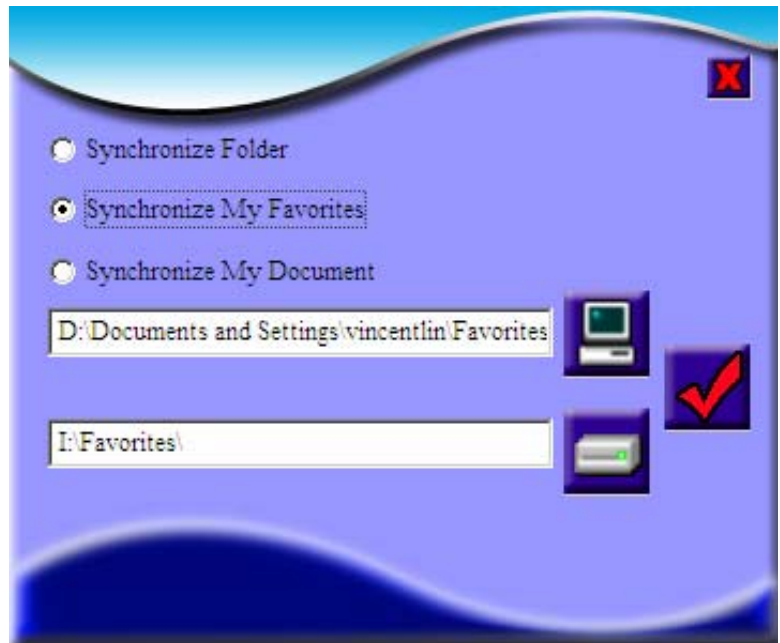

Select the folder on PC.



Select the folder on the USB flash drive.



Confirm the folder path and continue to next dialog.
See the **2.9.1 Synchronize File List**.



Cancel the setting and close the dialog.

2.9.1 Synchronize File List

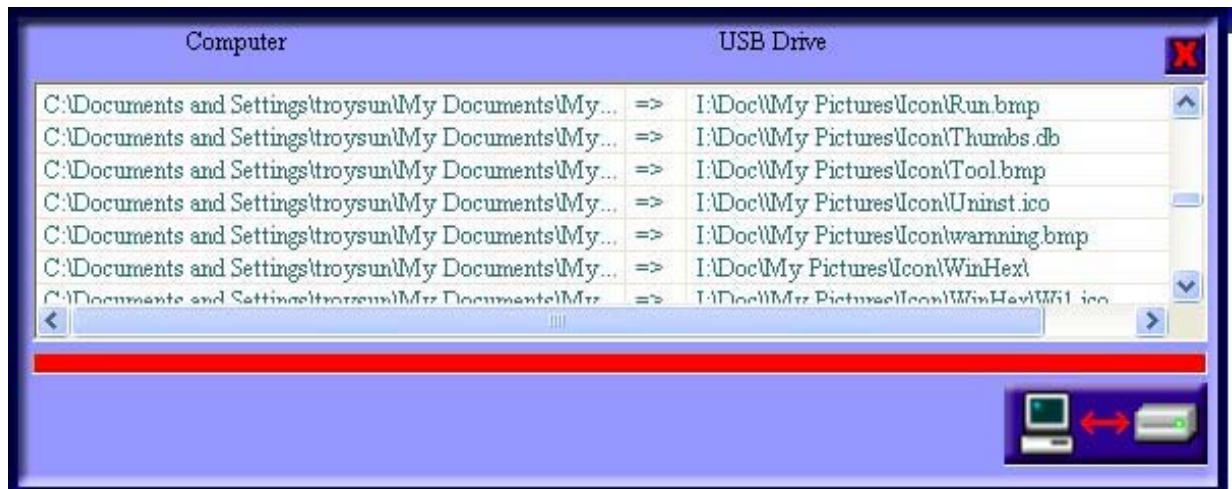

When you confirm the folder the program will pop-up a dialog to list all of the synchronized files. The left files are the data of the computer and the right files are the USB flash drive's data. Please note that files with older modified timestamp will be replaced with files with newer modified timestamp.



Click this button to start the data synchronization.



Close the dialog without data synchronization.

2.10 Mail Synchronize

This function synchronizes the **Microsoft Outlook**® data including mail inbox, outbox, journal, drafts, notes and address book. If the system has no **Microsoft Outlook**® installed, this function will be disabled and hidden.

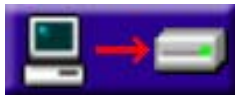
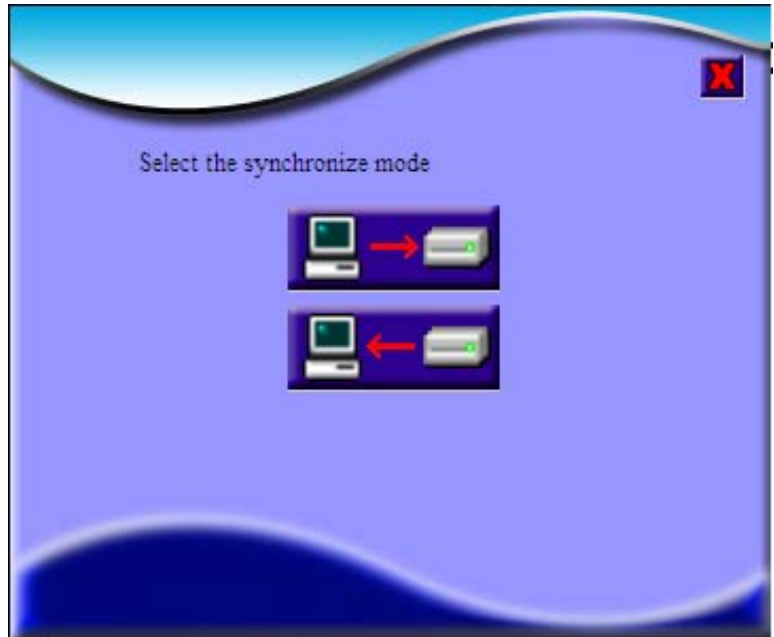

Select the synchronize direction from PC to USB flash drive. See **2.10.1 Synchronize Mail from PC to USB Flash Drive**.



Select the synchronize direction from USB flash drive to PC. See **2.10.1 Synchronize Mail from USB Flash Drive to PC**.

2.10.1 Synchronize Mail from PC to USB Flash Drive

The dialog is synchronizing mail from PC to USB flash drive. There are two modes for data update.

If you check the item **Update All of the Data**, the program will update all of the data from the last updated day to now.

If you check the item **Update the Data in the specific period**, the program will only update the data in the specific period. There is a calendar for selecting the specific month and day as the date is going to input. The period is based on last modified time. For example, a mail received five days ago will be modified, if the mail is replied today. So the last modified time of the mail is today, instead of five days ago.

This function will create a folder "Outlook Data" at the root of the USB flash drive. The folder below this path is named by the host name and the login name.

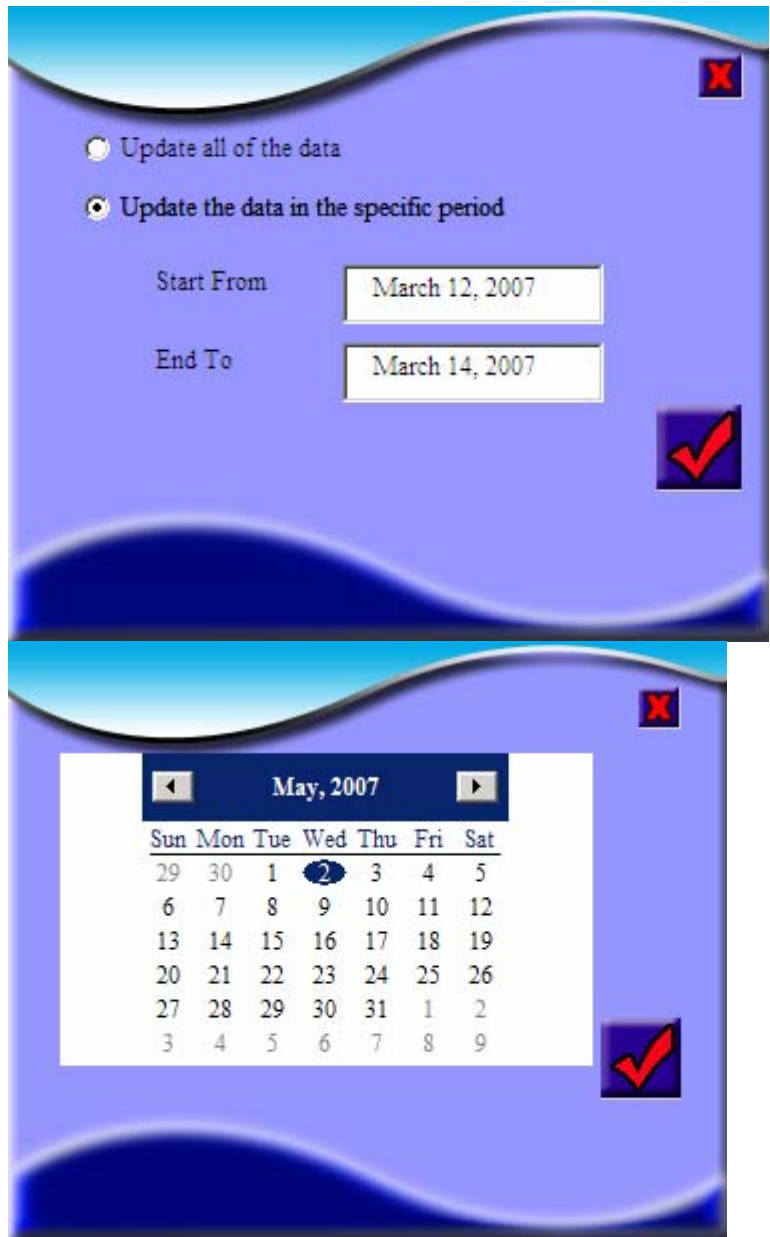

Confirm the setting and update the data to the USB drive.



Cancel the setting and close the dialog.

2.10.2 Synchronize Mail from USB Flash Drive to PC

The dialog shows up to synchronize mail from USB flash drive to PC. The users must select the account of the database of the **Outlook** mail. The account is named by the host name and the login name. The format is like below

“Host name”-“Login name”.

There are two conditions after login.

1. If the host name and the login name is the same as the current system status, the program assumes itself running on the original PC. Then the data on the USB flash drive will update to the **Outlook** folder directly.

1. If the host name and the login name are different from the current system status, it assumes itself not running on the original PC. The process will like below.

- A. The data on the USB flash drive will not update to the Outlook directly. It will copy the data to the folder “~**SyncUSB**” beside the “Personal Folder”.
- B. When you sent or received email completely, remember copy the mail or data from the “Personal Folder” to the “~**SyncUSB**”.
- C. Remember to logout from the **Outlook** by clicking the “**Mail Synchronize Logout**” item on the pull-down menu of the head-up panel. The folder “~**SyncUSB**” will disappear and the private data will update to the USB flash drive.

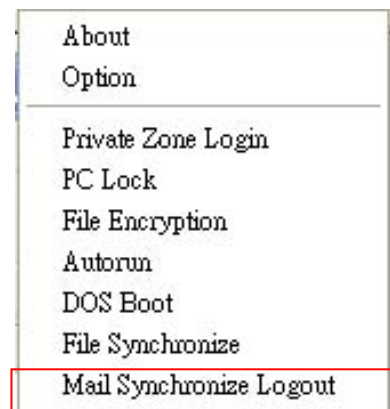

2.11 Disk Partition

Users can adjust the scroll bar to change the space of the two logical disks (volumes).

*** Warning: Partition the USB flash drive will initiate format operation to the USB flash drive and all of the data on the flash drive will lose. Please backup the data before running this function.**

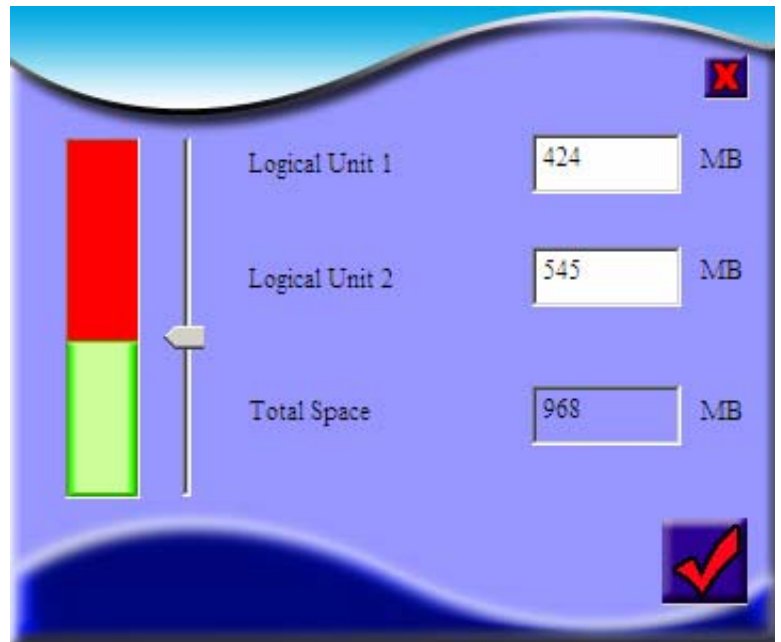

Confirm the setting and save to the USB flash drive.



Cancel the setting and close the dialog.

Message Index:

1. Incorrect Password:
Please re-key in your password and notice that the password is case sensitive.
2. Login to the Private Zone successfully:
3. Incorrect New Password:
The two passwords which you key in do not identical, please key in your password again.

